

# TOYO Duct Parts

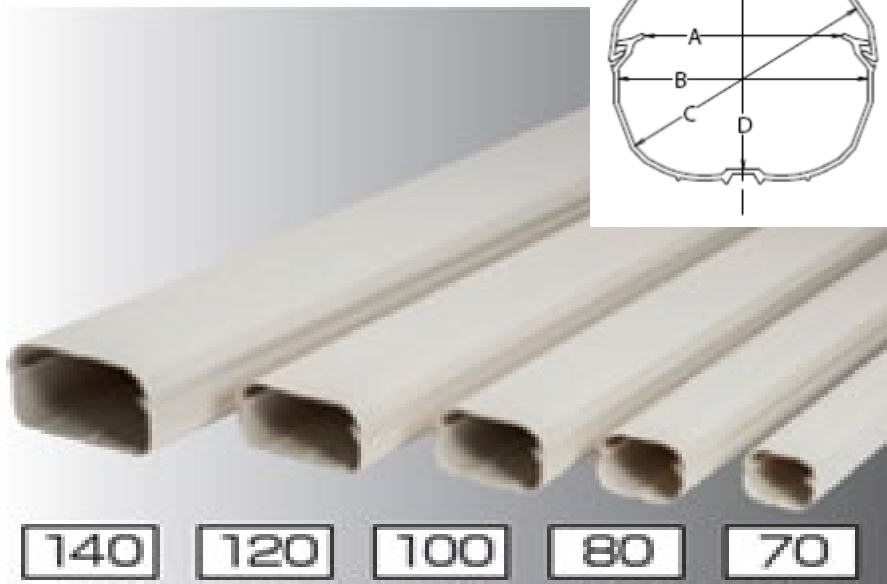

## TD Duct

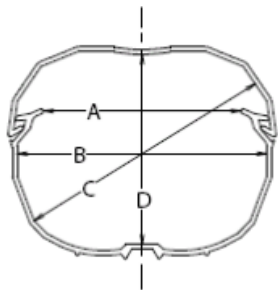

### Features;

- Polyvinyl chloride which has excellent durability and weatherability is mainly used to prevent deterioration over time.

### Notes for usage;

- As the ducts do not have water proof, contact point on the wall, joint, screw hole etc. are required coating or putty process is required.
- -20 to 60° is the temperature range to use.

Model #	Size (mm)				Q'ty
	A	B	C	E	
TD-70	42	57	63	48	5pcs x 3c/s
TD-80	60	73	78	58	5cs x 3c/s
TD-100	82	98	103	68	4pcs x 2c/s
TD-120	114	120	125	68	4pcs x 2c/s
TD-140	128	148	155	85	4pcs x 2c/s

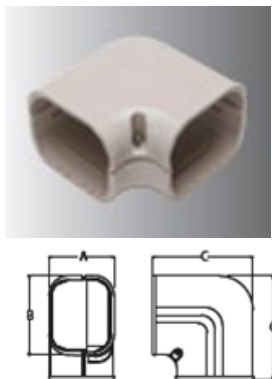

## DL Duct - Elbow

Model #	Size (mm)			Q'ty
	A	B	C	
DL-70	73	59	100	20
DL-80	86	70	110	20
DL-100	110	78	157	12
DL-120	130	81	176	10
DL-140	163	98	220	6



## DLW Duct - Elbow 45°

Model #	Size (mm)			Q'ty
	A	B	C	
DLW-70	73	59	60	20
DLW-80	82	73	69	20

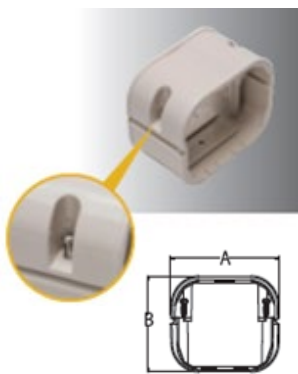

## DJ Duct - Joint

Model #	Size (mm)			Q'ty
	A	B	C	
DJ-70	73	59	50	50
DJ-80	86	70	50	50
DJ-100	110	78	65	25
DJ-120	130	81	79	20
DJ-140	161	98	89	10



## DS Duct - Sealing

Model #	Size (mm)				Q'ty
	A	B	C	D	
DS-80	107	86	120	139	20
DS-100	130	110	126	150	20
DS-120	159	136	135	159	10
DS-140	186	163	150	170	6

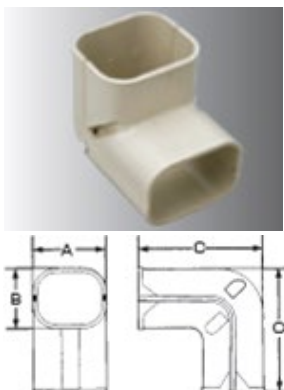

## DK Duct - Corner

Model #	Size (mm)			Q'ty
	A	B	C	
DK-70	73	59	120	20
DK-80	86	70	120	20
DK-100	110	78	121	20
DK-120	129	85	130	6
DK-140	161	98	140	6



## DIK Duct - Corner Mini

Model #	Size (mm)			Q'ty
	A	B	C	
DIK-80	86	70	103	20

# TOYO Duct Parts

## DC Duct Cap

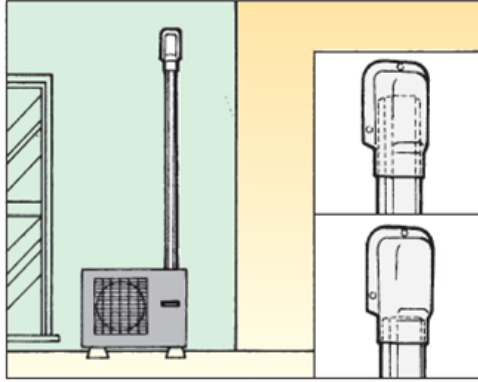
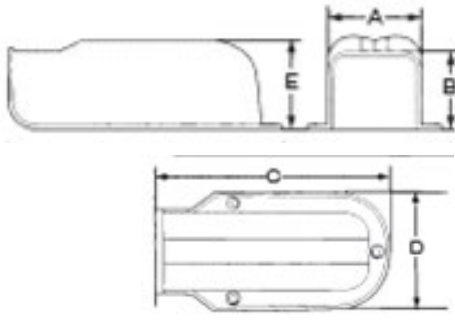

Cover the wall hole with duct cap

Model #	Size (mm)					Q'ty
	A	B	C	D	E	
DC-70	68	57	197	97	66	20
DC-80	81	68	211	111	82	15
DC-100	110	78	225	145	90	10
DC-120	128	80	260	164	110	20
DC-140	162	95	291	197	131	15

## DIS Conversion Socket

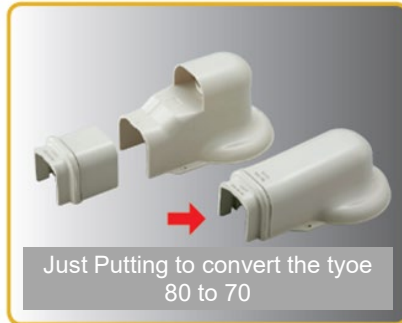
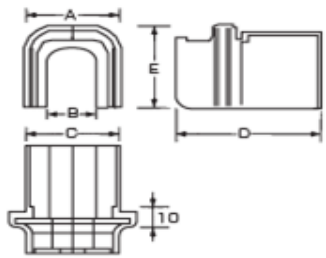

Just Putting to convert the type 80 to 70

Model #	Size (mm)					Q'ty
	A	B	C	D	E	
DIS-70-80	81	63	75	85	68	50

## DT Duct - Tees

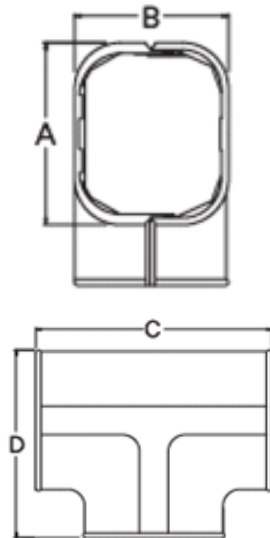

Model #	Size (mm)				Q'ty
	A	B	C	D	
DT-80	84	71	140	112	10
DT-120*	130	81	243	185	5

\* DT-120 includes two pcs Reducer DR-120 per quantity

## DR Duct - Reducer

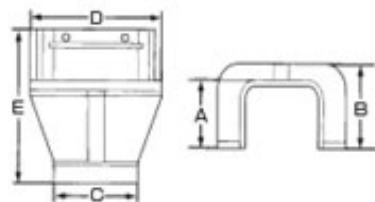

Model #	Size (mm)					Q'ty
	A	B	C	D	E	
DR-120	68	81	86	130	148	10

## DHC / DHBC

## Dust Waste Ventilation Duct Cap Mini / Big



DHC-80



DHBC-80

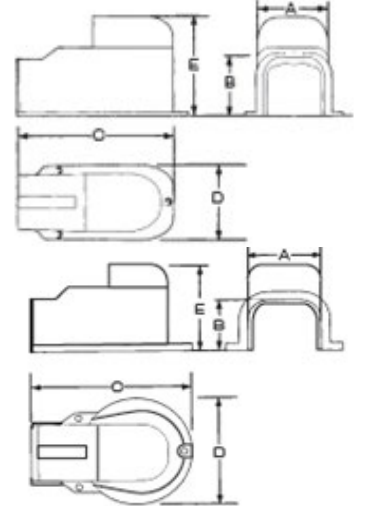

Model #	Size (mm)					Q'ty
	A	B	C	D	E	
DHC-80	81	68	207	109	128	10
DHBC-80	81	68	228	155	128	10

## DIC / DBC

## Duct Cap Mini / Big



DIC-80



DBC-80

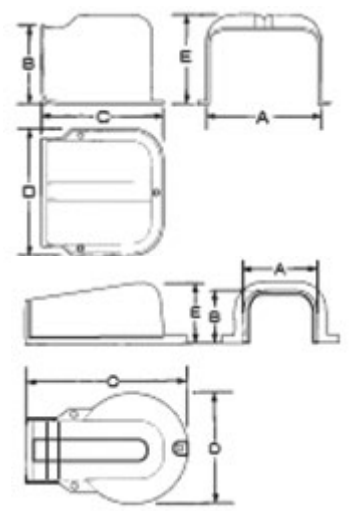

Model #	Size (mm)					Q'ty
	A	B	C	D	E	
DIC-80	81	68	120	111	82	20
DBC-80	81	68	215	155	82	20

## DE Duct - End Cap

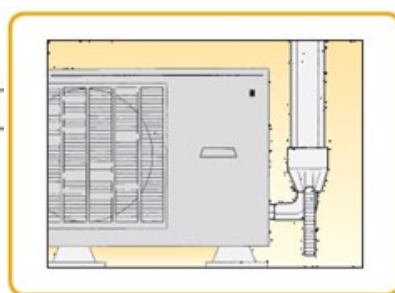
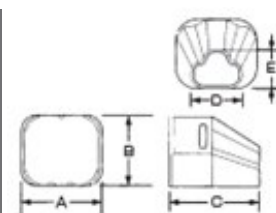

For fitting end

Model #	Size (mm)					Q'ty
	A	B	C	D	E	
DE-70	73	59	94	52	35	20
DE-80	86	70	95	52	45	20



# TOYO Duct Parts

## DSS Flexible Duct – 2M length

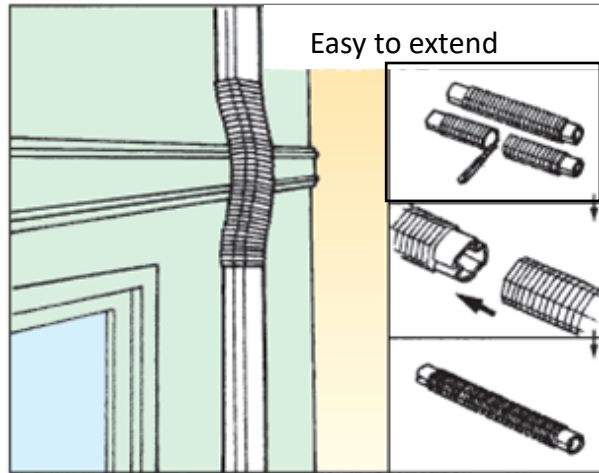
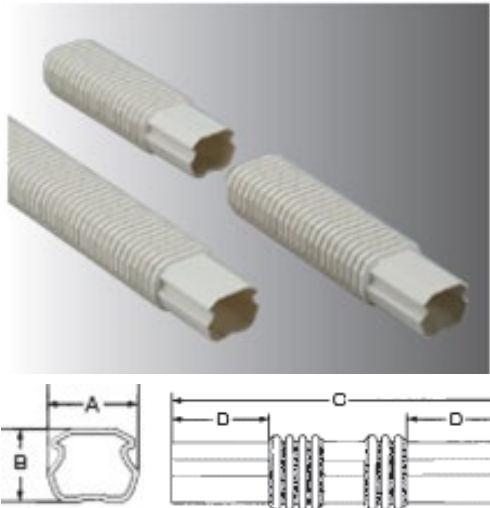

Model #	Size (mm)				Q'ty
	A	B	C	D	
DF-70S	59	50	633	75	20
DF-70L	59	50	1,200	75	15
DF-80	75	60	630	84	10
DF-80S	75	60	633	75	20
DF-80L	75	60	1,200	75	15
DF-100	95	65	780	78	8
DF-120	122	70	800	82	5
DF-140	140	85	918	86	4

## DSS Stainless Saddle



When use long flexible duct DF-70L or DF-80L, please use this saddle like below picture to fix.



Model #	Size (mm)				Q'ty
	A	B	C	D	
DSS-70	62	51	18	25	50
DSS-80	79	61	18	25	50

## DHK Duct Support Bracket (for horizontal lineset)

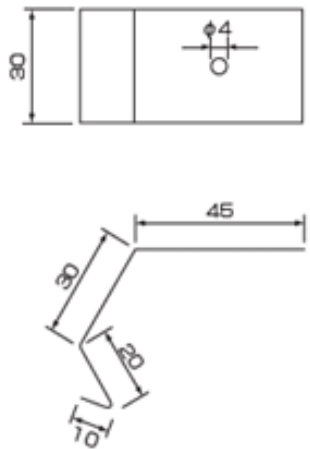
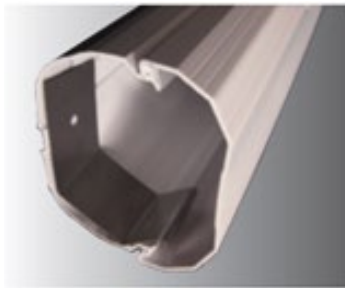

Metal bracket part to prevent duct deforming and falling of duct cover in horizontal linesetting.  
Recommend usage interval : about 50cm in duct

Model #	Material	Q'ty
DHK-80	S304	20 / bag

## KH Flexible Saddle



Model #	Color	Q'ty (pc x bag)
FS-10	Ivory	10 x 100
FSS-10 (with screws)	Ivory	10 x 100

Note : Min to Max diameter : 38 φ to 55φ

## KH Hole Cover

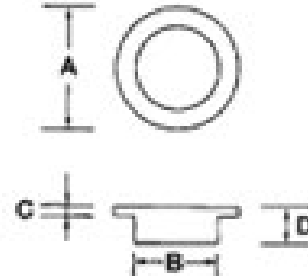

Code	Model #	Size (mm)				Applicable Hole Size	Wall Thickness	Q'ty
		A	B	C	D			
70246	KH-60	110	60	5	30	60~100 φ	50~250mm	50

Note : Ivory and White color are available in order to coordinate with wall color

## WC Wall Cap / Thin Version WCF Lid

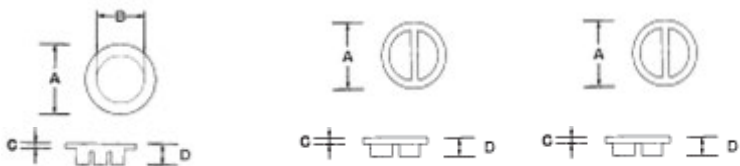
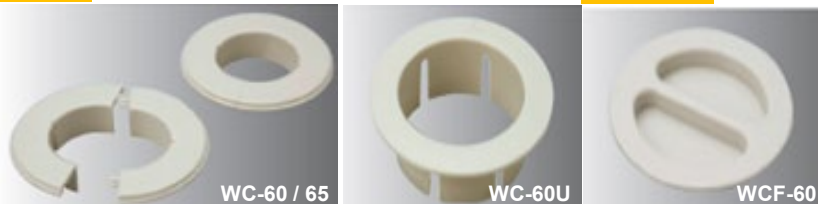

Code	Model #	Core drill Diameter	Size (mm)				Q'ty
			A	B	C	D	
70243	WC-60	65 φ	110	60	6	25	200
70241	WC-65	75 φ	110	65	5	28	200
70247	WC-60U	65 φ	85	58	2	26	200
70320	WCF-60	-	76	1	8	-	200

Note : Color / Ivory

## WP Wall Pipe WKP With Frange WFP With Frange Flexible ver

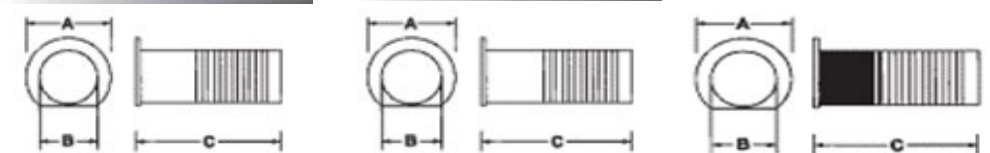

Code	Model #	Core drill Diameter	Size (mm)			Q'ty
			A	B	C	
70233	WP-60	65 φ	63	61	160	100
70231	WP-65	70 φ	69	67	200	100
70238	WKP-60	65 φ	84	61	210	100
170239	WKP-65	70 φ	89	66	210	100
70248	WFP-60	65 φ	84	63	230	100
70249	WFP-65	70 φ	92	68	230	100

Note : Color / Ivory  
WKP and WFP have scale to cut easily